



BAIT CONTAINER
CONNECT



OWNER'S MANUAL

WELCOME TO THE BAIT SAVIOUR SYSTEM

Please read this handbook to ensure you fully understand how to operate and maintain all parts of the Bait Saviour System.

This owner's manual is available in digital format on our website: www.baitsaviour.com

Contents

| | | | |
|--------------------------------------|-----|-----------------|-----|
| Get to know your Bait Saviour System | 1 | Using your Hub | 8 |
| Bait Container | 1.1 | Troubleshooting | 9 |
| Hub | 1.2 | Bait Container | 9.1 |
| How to use the Online Portal | 2 | Hub | 9.2 |
| Introduction | 2.1 | Warranty | 10 |
| Accessing the Portal | 2.2 | | |
| Create an account | 2.3 | | |
| Setting your Remote | 2.4 | | |
| Changing account details | 2.5 | | |
| Mounting your Bait Container | 3 | | |
| Setting the Time Mode | 4 | | |
| How to use the Bait Container | 5 | | |
| Charging your Control Box | 6 | | |
| Maintaining your Bait Container | 7 | | |

Get to know your Bait Container

Plan View (Open)

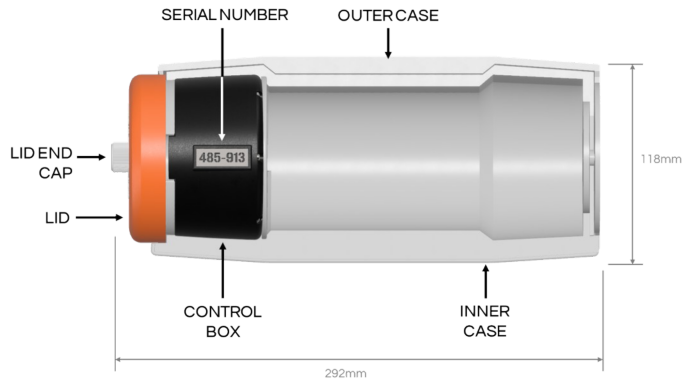

Plan View (Closed)



Side View (Open)

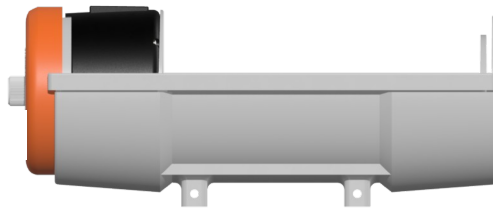

Side View (Closed)

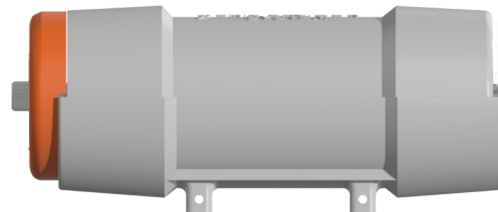

Get to know your Hub

Front View



Side View



Rear View



How to use the Online Portal - Introduction

The online portal is a web-based platform that allows users to manage and control their Bait Saviour System remotely. The portal provides a centralised and convenient way to monitor and update your settings.

The following are some of the key features of the online portal:

- 1) Remote time mode: Users can set the time modes and use the Remote to programme each Bait Container individually.
- 2) Hub synchronization: The portal automatically synchronises with the hub, ensuring that the most up-to-date information is available.

How to use the Online Portal - Accessing the portal

Accessing the Bait Saviour System Portal:

1) Open the web browser on your computer or mobile device and type "portal.baitsaviour.com" into the address bar and press enter to visit the website.

To make it easier to access each time on your mobile, you can add the Bait Saviour System Portal to Your Home Screen as follows:

For iOS users (Safari):

1) Once you've accessed portal.baitsaviour.com, tap the Share icon (square with an arrow pointing up) at the bottom of the screen.

2) Scroll down and tap "Add to Home Screen", edit the name (if necessary) and select "Add".

For Android users (Chrome):

1) After visiting portal.baitsaviour.com, tap the Menu icon (three vertical dots) in the top-right corner of the screen.

2) Tap "Add to Home screen", edit the name (if necessary) and select "Add".

By following these steps, you can quickly and easily access the Bait Saviour System Portal directly from your device's home screen.

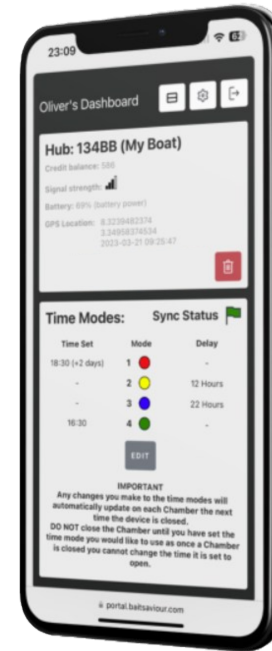

How to use the Online Portal - Create an account

1) Visit portal.baitsaviour.com on any computer or mobile device. Once the page loads, you'll see the login screen.

2) Use the email address you provided at checkout and the temporary passcode that we've emailed to you after purchase. Enter these details on the login screen.

3) Upon logging in for the first time, you'll be prompted to set your own secure password.

4) After setting your password, you'll be asked to review and accept our Terms & Conditions, Privacy Policy, and any other relevant agreements.

5) During your first login, you will also be asked to enter a one-time passcode (OTP) to register your device as a trusted device. This code will be sent to both your email address and, if available, as a text to your mobile.

(figure 2.3a)

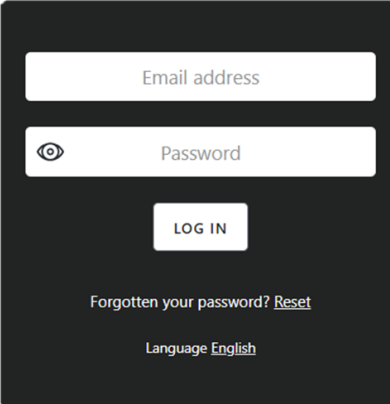

The image shows a dark-themed login form. At the top, there is a white input field labeled "Email address". Below it is another white input field labeled "Password" with an eye icon to its left. Underneath the password field is a white button with the text "LOG IN". At the bottom of the form, there is a link that says "Forgotten your password? [Reset](#)" and another link that says "Language [English](#)".

How to use the Online Portal - Setting your Remote

1) Log in to your online portal and navigate to the “Time Modes” section of your dashboard. Here, you will see modes 1-4 (figure 2.5a). To set these modes, click the Edit button.

2) Use the buttons labeled 1-4 at the top of the window to switch between Time Modes. For each mode, select whether you want it set to either “Time to Open” or “Time Delay”:

Time to Open: This option allows the Bait Container to open at a specific time, regardless of when it was closed. Select the desired time for the Bait Container to open. For example:

- If set to 10:30, the Bait Container will open at 10:30 regardless of when it was closed.
- If the Bait Container is closed before 10:30, it will open at this time on the same day.
- If the Bait Container is closed after 10:30, it will open at 10:30 the following day.

For longer soaks, use the day offset box at the bottom of the window to set the Bait Container to open a specific number of days (1-20) after being closed (figure 2.5b).

Time Delay: This option allows the Bait Container to open after a set period, measured in hours, from the time it was closed (figure 2.5c)

3) Once you are satisfied with the settings, click the **SAVE** button to apply your Time Modes.

4) The Sync Status flag, located in the top-right corner of the Time Modes section, will turn red, indicating that the changes have not yet updated on the Hub. When the flag turns green, the changes have successfully synced, and your Bait Containers will operate according to the latest settings.

(figure 2.5a)

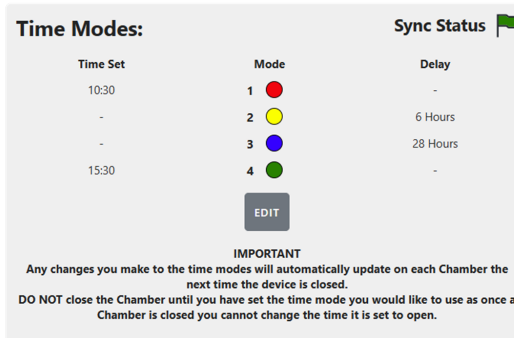

(figure 2.5b)

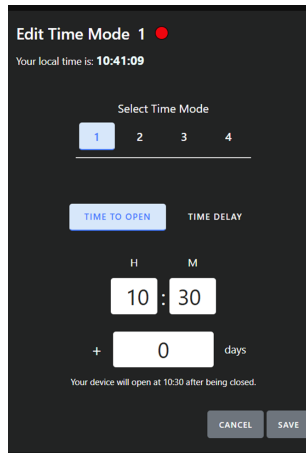

(figure 2.5c)

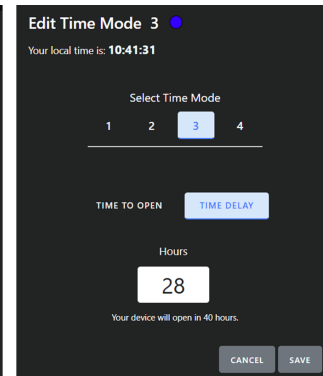

How to use the Online Portal - Changing account details

- 1) To change your account details, log in to the online portal using your username and password.
- 2) Click on the “Settings” icon in the top right hand side of the page (figure 2.6a).
- 3) Enter the one time passcode (OTP) as necessary. This will be sent as a text message to your mobile phone (if you have added a number to your account) as well as to your email address. Then select ok.
- 4) Once you have entered the OTP, you will be presented with a page where you can make the following changes to your account:
 - Reset your password
 - Update your account email address
 - Change your contact details & address
 - Manage trusted devices
 - Delete your account

(figure 2.6a)

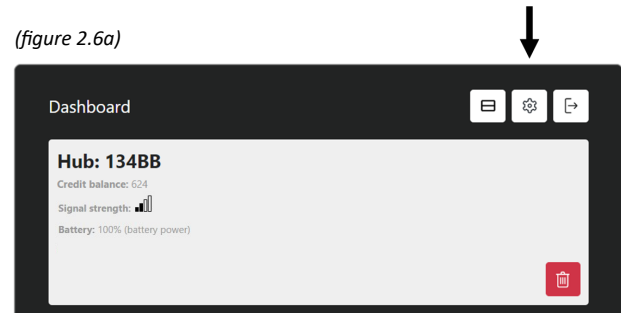

How to mount your Bait Container

For instructions on how to correctly fix your Bait Container in place and use it with the Bait Container, please scan the QR code to the right, or go to our website www.baitsaviour.com/support. Here you will find a set of videos which provides instructions for each different style of pot.

It is important that the mounting instructions are followed carefully to ensure reliable operation of the Bait Container.



www.baitsaviour.com/support

Setting the Time Mode

1) To set the time mode of a Bait Container, close the Bait Container and within 4 seconds, press and release the correct time mode button on the Remote.

2) When the Bait Container has been successfully set, the green LED on the top of the Remote will fast blink.

3) If you press the button too late and the Bait Container fails to set the time mode, the red LED on the top of the Remote will fast blink.

Note - There is no need to set the Bait Container with the Remote each time you want to use it. The Bait Container will remember the time mode it is set to. There is also no need to set a Bait Container each time you change a time mode online; simply change the value online and the Bait Container will



How to use the Bait Container

Using the Bait Container is a simple 3 step process:

- 1) Load the Bait Container with bait (figure 4a). Remember - you can start to reduce your bait consumption by up to 75%.
- 2) Rotate the inner case to close the Bait Container (figure 4b) Once closed, the countdown timer starts and the Bait Container begins the countdown to your desired opening time.
- 3) The Bait Container will then open at the desired time to bait your trap (figure 4c).

(figure 4a)

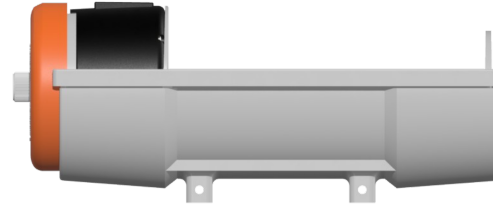

(figure 4b)



(figure 4c)



Charging your Control Box

Control Box

To remove the Control Box from your Bait Container, unscrew the lid upper part (1) and slide the Control Box out (2). Once out, simply place the control box flat side down in the center of your wireless charger (3). The light on your wireless charger will then turn blue to show the control box is charging.

The battery will fully charge within 8 hours. To check the battery level, simply place the Control Box back in the Bait Container, close the Bait Container and read the battery level on the online portal.

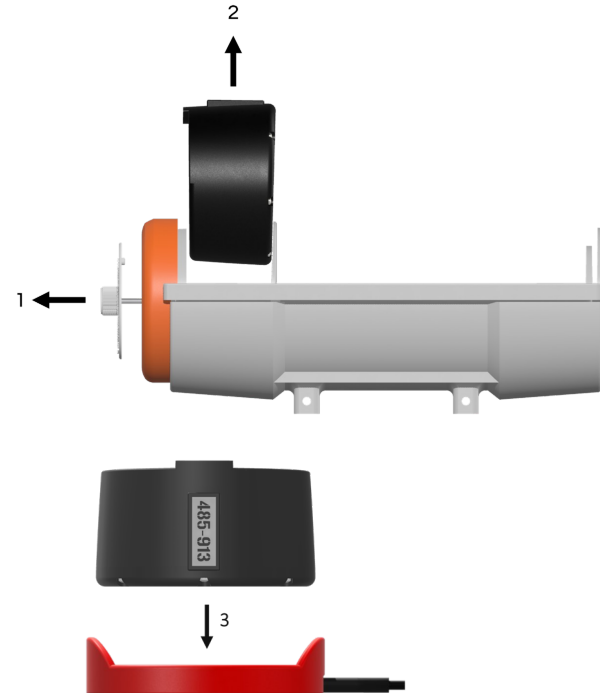

Maintaining your Bait Container

Keep your Bait Container relatively clean

Whilst the product has been designed to withstand harsh environments, rinsing under the lid (figure 7a) and in-between the cases from time to time is advised to remove any debris that may build up.

Storage

If you plan on storing the Bait Container out of the water for any prolonged period of time, ensure to thoroughly rinse all salt water off and store in a dry environment.

Depth

The Bait Container has been tested and certified to operate at depths up to 100 fathoms (183m). Using the product deeper than this can cause a complete failure of the Control Box, which is not covered under the product's warranty.

(figure 7a)

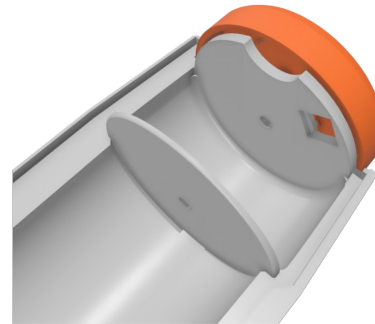

Using your Hub

Powering Your Hub

To power your hub, plug in a USB-C cable (figure 8a) connected to any 5V source, such as a USB outlet, battery bank or similar device. The hub accepts an input voltage between 5-24V. Once powered, the LED indicators on the front of the hub will display the following statuses:

- Red – Hub is powered but not ready to use
- Blinking Green – Hub is ready but has no GSM signal
- Solid Green – Hub is ready and has a GSM signal

Resetting Your Hub

If your hub requires a reset, unplug the power cable from the underside of the unit. Wait for 10 seconds, then reconnect the power cable.

Mounting Your Hub

Use the supplied holder to mount your hub securely. This holder has a suction cup that adheres firmly to any glass or smooth surface, allowing for easy installation within your cabin.

Where to Mount Your Hub

For optimal performance, mount your hub inside your cabin with a clear view of the sky to ensure strong GSM signals. Avoid placing the hub outdoors or in obstructed locations to maintain reliable connectivity.

(figure 8a)



Troubleshooting - Bait Container

Bait Container does not close

Physical Obstruction - Check to see if there is any debris between the cases or under the lid which is causing the issue. If you see anything, simply remove or rinse the product in a bucket of clean water.

Battery Level - If the Control Box battery runs out completely, the Bait Container will not close.

Bait Container does not stay closed

Battery Level - If the Control Box battery level drops below 15%, the Bait Container has been designed to not stay closed. If the battery life is 15% or under, charging the Control Box will resolve the issue. We recommend to charge your Bait Container as soon as it drops below 20%.

Hub not within range - If you are not within range of the Hub then the Bait Container will open after 10 seconds. Check the Hub is powered and nearby.

Bait Container does not open

Obstruction in the pot - Ensure the Bait Container is mounted correctly within the pot and is not obstructed.

Control box does not charge

Charger failure - Check the wireless charger provided with the Bait Container works by positioning another wireless charge compatible device on top. If this other device does not charge, there is a fault with the charger and it needs replacing.

Troubleshooting - Hub

Hub - 1 not communicating with online portal or Bait Container

If you encounter this issue with your Hub, the initial troubleshooting step is to perform a full unit reset. To do this, turn off the Hub for 1 minute. Once complete, turn back on. After a few minutes, all functionality should be restored and the unit should operate as expected. If the Hub is still not communicating with your Bait Container's and online portal, please contact us.

Warranty

Each item is sold with 12 months of warranty This includes:

- Any defects in materials used to manufacture your product
- Any defects in workmanship under normal use
- Any broken components under normal use

The warranty does not cover:

- Damage of a product resulting from negligence
 - Damage of a product resulting from unauthorised modification of the product
 - Damage caused by natural disaster
 - Theft or loss of the product
-



THE FUTURE OF LOBSTER FISHING IS HERE

DESIGNED & ASSEMBLED IN THE UK - MADE IN CHINA